

## **Procedures to file a request to the State Intellectual Property Office of the P. R. China (SIPO) for Patent Prosecution Highway Pilot Program between the SIPO and the Spanish Patent and Trademark Office (SPTO)**

The pilot period of this PPH pilot program commence on January 1, 2014, for a duration of three years and ending on December 31, 2016. The pilot period may be extended if necessary until the SIPO and SPTO receive the sufficient number of PPH requests to adequately assess the feasibility of PPH program.

The Offices may also terminate the PPH pilot program if the volume of participation exceeds manageable level, or for any other reason. Ex Ante notice will be published if the PPH pilot program is terminated.

### **Part I** **PPH using the national work products from the SPTO**

Applicants can request accelerated examination by a prescribed procedure including submission of relevant documents on an application which is filed with the SIPO and satisfies the following requirements under the SIPO-SPTO Patent Prosecution Highway (PPH) pilot program based on the SPTO application.

When filing a request for the PPH pilot program, an applicant must submit a request form "Request for Participation in the Patent Prosecution Highway Pilot Program" to the SIPO.

#### **1. Requirements**

- (a) *The SIPO application (including PCT national phase application) is***
- (i) *an application which validly claims priority under the Paris Convention to the SPTO application(s) (examples are provided in ANNEX I, Figure A, B, C, F, G and H),***  
**or**
  - (ii) *a PCT national phase application without priority claim (examples are provided in Annex I, Figure I and K), or***
  - (iii) *an application which validly claims priority under the Paris Convention to the PCT application(s) without priority claim (examples are provided in ANNEX I, Figure J and L).***

The SIPO application, which validly claims priority to multiple SPTO or direct PCT applications, or which is the divisional application validly based on the originally filed application that is included in (i) to (iii) above, is also eligible.

**(b) At least one corresponding application exists in the SPTO and has one or more claims that are determined to be patentable/allowable by the SPTO.**

The corresponding application(s) can be the application which forms the basis of the priority claim, an application which derived from the SPTO application which forms the basis of the priority claim (e.g., a divisional application of the SPTO application or an application which claims domestic priority to the SPTO application (see Figure C in Annex I)), or a SPTO national phase application of a PCT application (see Figures H, I, J, K and L in Annex I).

Claims are “determined to be allowable/patentable” when the SPTO examiner explicitly identified the claims to be allowable/patentable in the latest office action, even if the application is not granted for patent yet.

The office action includes: Granted Patent Publication and/or the “Resolución de concesión con examen previo de la solicitud de patente” (Granting decision) as part of the substantive examination procedure.

**(c) All claims in the SIPO application (for which an accelerated examination under the PPH pilot program is requested), as originally filed or as amended, must sufficiently correspond to one or more of those claims determined to be patentable/allowable in the SPTO.**

Claims are considered to “sufficiently correspond” where, accounting for differences due to translations and claim format, the claims in the SIPO are of the same or similar scope as the claims in the SPTO, or the claims in the SIPO are narrower in scope than the claims in the SPTO. In this regard, a claim that is narrower in scope occurs when a SPTO claim is amended to be further limited by an additional technical feature that is supported in the specification (description and/or claims). A claim in the SIPO which introduces a new/different category of claims to those claims determined to be patentable/allowable in the SPTO is not considered to sufficiently correspond. For example, the SPTO claims only contain claims to a process of manufacturing a product, then the claims in the SIPO are not considered to sufficiently correspond if the SIPO claims introduce product claims that are dependent on the corresponding process claims.

It is not necessary to include “all” claims determined to be patentable/allowable in the SPTO in an application in the SIPO (the deletion of claims is allowable). For example, in the case where an application in the SPTO contains 5 claims determined to be patentable/allowable, the application in the SIPO may contain only 3 of these 5 claims.

Any claims amended or added after the grant of the request for participation in the PPH pilot program need to sufficiently correspond to the claims indicated as patentable/allowable in the SPTO application when applicants have not received any office

action related to substantive examination. Any claims amended or added after the grant of the request for participation in the PPH pilot program need not to sufficiently correspond to the claims indicated as patentable/allowable in the SPTO application when applicants need to amend claims in order to overcome the reasons for refusal raised by examiners. Any amendment outside of the claim correspondence requirement is subject to examiners' discretion.

Note that any applicant to the SIPO may amend the application including its claims on its or his own initiative when a request for substantive examination is made, and within the time limit of three months after the receipt of the *Notice of Invention Patent Application Entering into Substantive Examination Stage*. Therefore, an applicant needs to care about the time limit of amendment in order to make claims in the SIPO application correspond to the claims determined to be patentable/allowable in the SPTO.

**(d) *The SIPO application must have been published.***

The applicant must have received the *Notice of Publication of Invention Patent Application* issued from the SIPO before, or when, filing the PPH request.

**(e) *The SIPO application must have entered into substantive examination stage.***

The applicant must have received the *Notice of Invention Patent Application Entering into Substantive Examination Stage* issued from the SIPO before, or when, filing the PPH request.

Note that as an exception, the applicant may file a PPH request simultaneously with the Request for Substantive Examination.

**(f) *The SIPO has not begun examination of the application at the time of request for the PPH.***

The applicant should have not received any office action issued from the substantive examination departments in the SIPO before, or when, filing the PPH request.

**(g) *The SIPO application must be electronic patent application.***

## **2. Documents to be submitted**

Documents (a) to (d) below must be submitted by attaching to "*Request for Participation in the Patent Prosecution Highway Pilot Program*".

Note that even when it is not needed to submit certain documents below, the name of the documents must be listed in the "*Request for Participation in the Patent Prosecution Highway Pilot Program*" (Please refer to the example form below for the details).

- (a) **Copies of all office actions (which are relevant to substantive examination for patentability in the SPTO) which were issued for the corresponding application by the SPTO, and translations of them.**

Either Chinese or English is acceptable as translation language.

If it is impossible for the examiner to understand the translated office action, the examiner can request the applicant to resubmit translations.

- (b) **Copies of all claims determined to be patentable/allowable by the SPTO, and translations of them.**

Either Chinese or English is acceptable as translation language.

If it is impossible for the examiner to understand the translated claims, the examiner can request the applicant to resubmit translations.

- (c) **Copies of references cited by the SPTO examiner**

The documents to be submitted are those cited in the above-mentioned office actions. Documents which are only referred to as references and consequently do not consist of the reasons for refusal do not have to be submitted.

If the references are patent documents, the applicant doesn't have to submit them<sup>1</sup>. When the SIPO does not possess the patent document, the applicant has to submit the patent document at the examiner's request. Non-patent literature must always be submitted. The translations of the references are unnecessary.

- (d) **Claim correspondence table**

The applicant requesting PPH must submit a claim correspondence table, which indicates how all claims in the SIPO application sufficiently correspond to the patentable/allowable claims in the SPTO application.

When claims are just literal translation, the applicant can just write down that "they are the same" in the table. When claims are not just literal translation, it is necessary to explain the sufficient correspondence of each claim based on the criteria 1. (c) (Please refer to the example form below).

When the applicant has already submitted above documents (a) to (d) to the SIPO through simultaneous or past procedures, the applicant may incorporate the documents by reference and does not have to attach them.

---

<sup>1</sup> Note that even when it is not needed to submit copies of references, the name of the references must be listed in the "Request for Participation in the Patent Prosecution Highway Pilot Program".

### **3. “Request for Participation in the Patent Prosecution Highway Pilot Program” for filing request of an accelerated examination under the PPH pilot program**

#### **(1) Circumstances**

When an applicant files a request for an accelerated examination under the PPH pilot program to the SIPO, the applicant must submit a request form “*Request for participation in the Patent Prosecution Highway Pilot Program*”.

The applicant must indicate that the application is included in (i) to (iii) of 1. (a), and that the accelerated examination is requested under the PPH pilot program. The application number, publication number, or a patent number of the corresponding SPTO application(s) also must be written.

In the case that the application which has one or more claims that are determined to be patentable/allowable is different from the SPTO application(s) included in (i) to (iii) of 1. (a) (for example, the divisional application of the basic application), the application number, publication number, or a patent number of the application(s) which has claims determined to be patentable/allowable and the relationship between those applications also must be written.

#### **(2) Documents to be submitted**

The applicant must list all required documents mentioned above 2. in an identifiable way, even when the applicant omits to submit certain documents.

#### **(3) Notice**

An applicant can file the “*Request for Participation in the Patent Prosecution Highway Program*” to the SIPO through on-line procedures only.

### **4. Procedure for the accelerated examination under the PPH pilot program**

The SIPO decides whether the application can be entitled to the status for an accelerated examination under the PPH when it receives a request with the documents stated above. When the SIPO decides that the request is acceptable, the application is assigned a special status for an accelerated examination under the PPH.

In those instances where the request does not meet all the requirements set forth above, the applicant will be notified and the defects in the request will be identified. The applicant may be given opportunity, one time only, to correct certain specified defects. If the request is not approved, the applicant may resubmit the request up to one time. If the resubmitted request is still not approved, the applicant will be notified and the application will await action in its regular turn.

## **Part II**

### **PPH using the PCT international work products from the SPTO**

Applicants can request accelerated examination by a prescribed procedure including submission of relevant documents on an application which is filed with the SIPO and satisfies the following requirements under the SIPO-SPTO Patent Prosecution Highway pilot program based on PCT international work products (PCT-PPH pilot program).

When filing a request for the PCT-PPH pilot program, an applicant must submit a request form “*Request for Participation in the Patent Prosecution Highway Pilot Program*” to the SIPO.

#### **1. Requirements**

The application which is filed with the SIPO and on which the applicant files a request under the PCT-PPH must satisfy the following requirements:

- (1) The latest work product in the international phase of a PCT application corresponding to the application (“international work product”), namely the Written Opinion of International Search Authority (WO/ISA), the Written Opinion of International Preliminary Examination Authority (WO/IPEA) or the International Preliminary Examination Report (IPER), indicates at least one claim as patentable/allowable (from the aspect of novelty, inventive steps and industrial applicability).**

Note that the ISA and the IPEA which produced the WO/ISA, WO/IPEA and the IPER are limited to the SPTO, but, if priority is claimed, the priority claim can be to an application in any Office, see example A' in Annex II (application ZZ can be any national application).

The applicant cannot file a request under PCT-PPH on the basis of an International Search Report (ISR) only.

In case any observation is described in Box VIII of WO/ISA, WO/IPEA or IPER which forms the basis of a PCT-PPH request, the application will not be eligible for participating in PCT-PPH pilot program.

- (2) The relationship between the application and the corresponding international application satisfies one of the following requirements:**

- (A) The application is a national phase application of the corresponding international application. (See Figures A, A', and A'' in Annex II)**
- (B) The application is a national application as a basis of the priority claim of the corresponding international application. (See Figure B in Annex II)**
- (C) The application is a national phase application of an international application**

**claiming priority from the corresponding international application. (See Figure C in Annex II)**

**(D) The application is a national application claiming foreign/domestic priority from the corresponding international application. (See Figure D in Annex II)**

**(E) The application is the derivative application (divisional application and application claiming domestic priority etc.) of the application which satisfies one of the above requirements (A) – (D). (See Figures E1 and E2 in Annex II)**

**(3) All claims on file, as originally filed or as amended, for examination under the PCT-PPH must sufficiently correspond to one or more of those claims indicated to be patentable/allowable in the latest international work product of the corresponding international application.**

Claims are considered to "sufficiently correspond" where, accounting for differences due to translations and claim format, the claims of the application are of the same or similar scope as the claims indicated to be patentable/allowable in the latest international work product, or the claims of the application are narrower in scope than the claims indicated to be patentable/allowable in the latest international work product.

In this regard, a claim that is narrower in scope occurs when a claim indicated to be patentable/allowable in the latest international work product is amended to be further limited by an additional feature that is supported in the specification (description and/or claims) of the application.

A claim of the application which introduces a new/different category of claims to those claims indicated to be patentable/allowable in the latest international work product is not considered to sufficiently correspond. For example, the claims indicated to be patentable/allowable in the latest international work product only contain claims to a process of manufacturing a product, then the claims of the application are not considered to sufficiently correspond if the claims of the application introduce product claims that are dependent on the corresponding process claims.

It is not necessary to include "all" claims determined to be patentable/allowable in the corresponding international application in an application in the SIPO (the deletion of claims is allowable). For example, in the case where the corresponding international application contains 5 claims determined to be patentable/allowable, the application in the SIPO may contain only 3 of these 5 claims.

Any claims amended or added after the grant of the request for participation in the PCT-PPH pilot program need to sufficiently correspond to the claims indicated as patentable/allowable in the latest international work product when applicants have not received any office action related to substantive examination. Any claims amended or added after the grant of the request for participation in the PCT-PPH pilot program need not to sufficiently correspond to the claims

indicated as patentable/allowable in the latest international work product when applicants need to amend claims in order to overcome the reasons for refusal raised by examiners. Any amendment outside of the claim correspondence requirement is subject to examiners' discretion.

Note that any applicant to the SIPO may amend the application including its claims on its or his own initiative when a request for substantive examination is made, and within the time limit of three months after the receipt of the *Notice of Invention Patent Application Entering into Substantive Examination Stage*. Therefore, an applicant needs to care about the time limit of amendment in order to make claims in the SIPO application correspond to claims determined to be patentable/allowable in the latest international work product.

**(4) The application must have been published.**

The applicant must have received the *Notice of Publication of Invention Patent Application* issued from the SIPO before, or when, filing the PPH request.

**(5) The application must have entered into substantive examination stage.**

The applicant must have received the *Notice of Invention Patent Application Entering into Substantive Examination Stage* issued from the SIPO before, or when, filing the PPH request. Note that as an exception, the applicant may file a PPH request simultaneously with the Request for Substantive Examination.

**(6) The SIPO has not begun examination of the application at the time of request for the PCT-PPH.**

The applicant should have not received any office action issued from the substantive examination departments in the SIPO before, or when, filing the PCT-PPH request.

**(7) The application must be electronic patent application.**

**2. Documents to be submitted**

The applicant must submit the following documents attached to the request form in filing a request under PCT-PPH. Some of the documents may not be required to submit in certain cases.

Note that even when it is not needed to submit certain documents below, the name of the documents must be listed in the "*Request for Participation in the Patent Prosecution Highway Pilot Program*" (Please refer to the Example form below for the details).

**(1) A copy of the latest international work product which indicated the claims to be**



**patentable/allowable and their Chinese or English translations.**

In case the application satisfies the relationship 1.(2)(A), the applicant need not submit a copy of the International Preliminary Report on Patentability (IPRP) and any English translations thereof because a copy of these documents is already contained in the file-wrapper of the application<sup>2</sup>. In addition, if the copy of the latest international work product and the copy of the translation are available via “PATENTSCOPE (registered trademark)”<sup>3</sup>, an applicant need not submit these documents, unless otherwise requested by the SIPO.

(WO/ISA and IPER are usually available as “IPRP Chapter I” and “IPRP Chapter II” respectively in 30 months after the priority date.)

If it is impossible for the examiner to understand the translated international work product, the examiner can request the applicant to resubmit translations.

**(2) A copy of a set of claims which the latest international work product of the corresponding international application indicated to be patentable/allowable and their Chinese or English translations.**

If the copy of the set of claims which are indicated to be patentable/allowable is available via “PATENTSCOPE (registered trademark)”<sup>4</sup> (e.g. the international Patent Gazette has been published), an applicant need not submit this document unless otherwise requested by the SIPO. Where the set of claims is written in Spanish, the translations thereof must be still submitted by an applicant.

If it is impossible for the examiner to understand the translated claims, the examiner can request the applicant to resubmit translations.

**(3) A copy of references cited in the latest international work product of the international application corresponding to the application.**

Documents which are only referred to as references and consequently do not consist of the reasons for refusal do not have to be submitted.

If the reference is a patent document, the applicant is not required to submit it<sup>5</sup>. In case the SIPO has difficulty in obtaining the document, however, the applicant may be asked to submit it. Non-patent literature must always be submitted. Translations of cited references are unnecessary.

**(4) A claims correspondence table which indicates how all claims in the application**

---

<sup>2</sup> Note that even when it is not needed for the applicant to submit copies of the latest international work product and their translation, the name of the document must be listed in the “*Request for Participation in the Patent Prosecution Highway Pilot Program*”.

<sup>3</sup> <http://www.wipo.int/pctdb/en/index.jsp>

<sup>4</sup> <http://www.wipo.int/pctdb/en/index.jsp>

<sup>5</sup> Note that even when it is not needed to submit copies of references, the name of the references must be listed in the “*Request for Participation in the Patent Prosecution Highway Pilot Program*”.

**sufficiently correspond to the claims indicated to be patentable/allowable.**

When claims are just literal translation, the applicant can just write down that “they are the same” in the table. When claims are not just literal translation, it is necessary to explain the sufficient correspondence of each claim based on the criteria 1. (3) (Please refer to the Example form below).

When an applicant has already submitted the above mentioned documents (1) - (4) to the SIPO through simultaneous or past procedures, the applicant may incorporate the documents by reference and is thus not required to attach the documents.

**3. “Request for Participation in the Patent Prosecution Highway Pilot Program” for filing request of an accelerated examination under the PCT-PPH pilot program**

**(1) Circumstances**

The applicant must indicate that the application is included in (A) to (E) of 1. (2), and that the accelerated examination is requested under the PCT-PPH pilot program. The application number(s) of the corresponding international application(s) also must be written.

**(2) Documents to be submitted**

The applicant must list all required documents mentioned above 2. in an identifiable way, even when applicant omits to submit certain documents.

**(3) Notice**

An applicant can file the “Request for Participation in the Patent Prosecution Highway Program” to the SIPO through on-line procedures only.

**4. Procedure for the accelerated examination under the PPH pilot program**

The SIPO decides whether the application can be entitled to the status for an accelerated examination under the PCT-PPH when it receives a request with the documents stated above. When the SIPO decides that the request is acceptable, the application is assigned a special status for an accelerated examination under the PCT-PPH.

In those instances where the request does not meet all the requirements set forth above, the applicant will be notified and the defects in the request will be identified. The applicant may be given opportunity, one time only, to correct certain specified defects. If the request is not approved, the applicant may resubmit the request up to one time. If the resubmitted request is still not approved, the applicant will be notified and the application will await action in its regular turn.

**Example form of Request for participation in the Patent Prosecution Highway Program (Conventional PPH and PCT-PPH all inclusive)**

**参与专利审查高速路 (PPH) 项目请求表**

# PPH

*Request for participation in the Patent Prosecution Highway Program*

		此框由国家知识产权局填写 <i>This frame will be filled in by SIPO</i>	
① 专 利 申 请	申请号: <i>Application Number here</i>	请求日:	
	申请人: <i>Applicant Name here</i>	申请号条码:	
	发明名称: <i>Title of Invention here</i>	挂号号码:	
② 说 明 事 项	<p>根据专利审查高速路项目的相关规定, 请求对上述申请进行加快审查。 <i>Request accelerated examination of said application according to relevant guidelines on participation in the Patent Prosecution Highway Pilot Program</i></p> <p><input type="checkbox"/> 请求参与常规的 PPH <i>Check if request for participation in conventional PPH</i></p> <p><input type="checkbox"/> 请求参与 PCT-PPH <i>Check if request for participation in PCT- PPH</i></p>		
③ 对 应 申 请 声 明	对应申请号/公开号/专利号/国际申请号 <i>Application Number, publication number, or patent number of the corresponding applications</i>	对应申请审查机构名称 <i>Name of the Examination Authority of the corresponding applications</i>	相关申请对应关系 <i>Relationship between said application and the corresponding applications</i>

<p>④ 附 加 文 件 清 单</p>	<p>申请人随本 PPH 请求表一起提交了下列文件：</p> <p><i>Documents accompanying the request form</i></p> <p><input type="checkbox"/> 对应申请的所有可授权权利要求书副本及其译文：</p> <p>    1. 对应申请_____，由____于____年____月____日作出的_____通知书所针对的权利要求书副本及其译文</p> <p>    2. 对应申请_____，由____于____年____月____日作出的_____通知书所针对的权利要求书副本及其译文</p> <p><i>Check if copies of all claims determined to be patentable/allowable in the corresponding application, and translations of them submitted; write down claims are determined to be patentable/allowable in which office action issued by which office on what date; in the case that said application corresponds to more than one corresponding application, write down each corresponding application number.</i></p> <p><input type="checkbox"/> 对应申请的审查意见通知书副本及其译文，各文件名称如下：</p> <p>    1. 对应申请_____：</p> <p>        1) 由____于____年____月____日作出的_____通知书副本及其译文</p> <p>        2) 由____于____年____月____日作出的_____通知书副本及其译文</p> <p>    2. 对应申请_____：</p> <p>        1) 由____于____年____月____日作出的_____通知书副本及其译文</p> <p>        2) 由____于____年____月____日作出的_____通知书副本及其译文</p> <p><i>Check if copies of all office actions (which are relevant to substantive examination for patentability) which were issued for the corresponding application, and translations of them submitted; write down which office action was issued by which office on what date; in the case that said application corresponds to more than one corresponding application, write down each corresponding application number.</i></p> <p><input type="checkbox"/> 权利要求的对应表</p> <p><i>Check if claim correspondence table submitted</i></p> <p><input type="checkbox"/> 对应申请的审查意见引用文件副本，各文件名称如下：</p> <p>    1. _____</p> <p>    2. _____</p> <p><i>Check if copies of references cited in all office actions which were issued for the corresponding application submitted; write down the names of references even if omitted for submission</i></p> <p><input type="checkbox"/> 其他证明文件</p> <p>    1. _____</p> <p><i>Check if other documents submitted; write down the names of documents</i></p>
--	--

Part II PPH using the PCT international work products from the SPTO

<p>⑤ 申请人或专利代理机构签字或盖章 <i>Signature or seal by applicant or its agent</i></p> <p style="text-align: right;">年 月 日</p>	<p>⑥ 国家知识产权局处理意见 <i>Decision on this request by SIPO</i></p> <p style="text-align: right;">年 月 日</p>
---	--

本申请的 权利要求 <i>Claims in this application</i>	对应申请中被认为可 授权的对应权利要求 <i>Patentable/Allowable claims in the corresponding application</i>	关于对应性的说明 <i>Comments on the correspondence</i>
1	1	完全相同 Both claims are the same
2	2	完全相同 Both claims are the same
3	1	<p>权利要求 3 在对应申请权利要求 1 的基础上引入了说明书第 X 页第 X 段记载的技术特征 X</p> <p>Claim 3 is further limited by an additional technical feature recorded in Paragraph X, Page X in the specification on the basis of Claim 1 in the corresponding application.</p>
4	2	<p>权利要求 4 在对应申请权利要求 2 的基础上引入了说明书第 Y 页第 Y 段记载的技术特征 Y</p> <p>Claim 4 is further limited by an additional technical feature recorded in Paragraph Y, Page Y in the specification on the basis of Claim 2 in the corresponding application.</p>
5	1	<p>权利要求 5 在对应申请权利要求 1 的基础上引入了说明书第 Z 页第 Z 段记载的技术特征 Z</p> <p>Claim 5 is further limited by an additional technical feature recorded in Paragraph Z, Page Z in the specification on the basis of Claim 1 in the corresponding application.</p>

# ANNEX I

**A**

A case meeting requirement (a) (i)  
- Paris route -

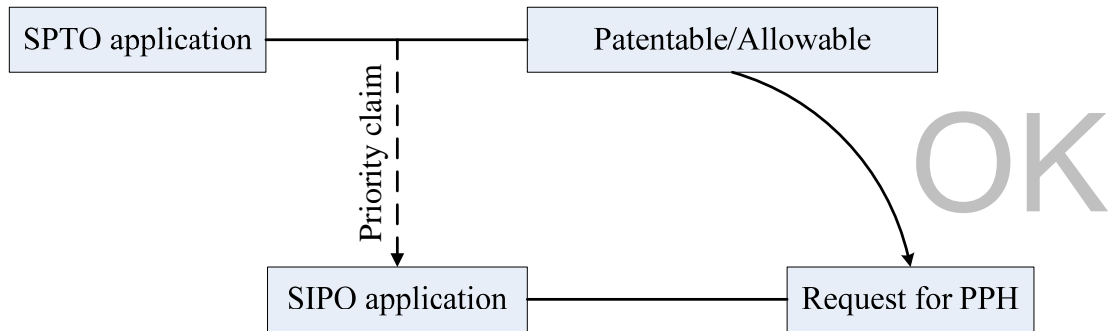

**B**

A case meeting requirement (a) (i)  
- PCT route -

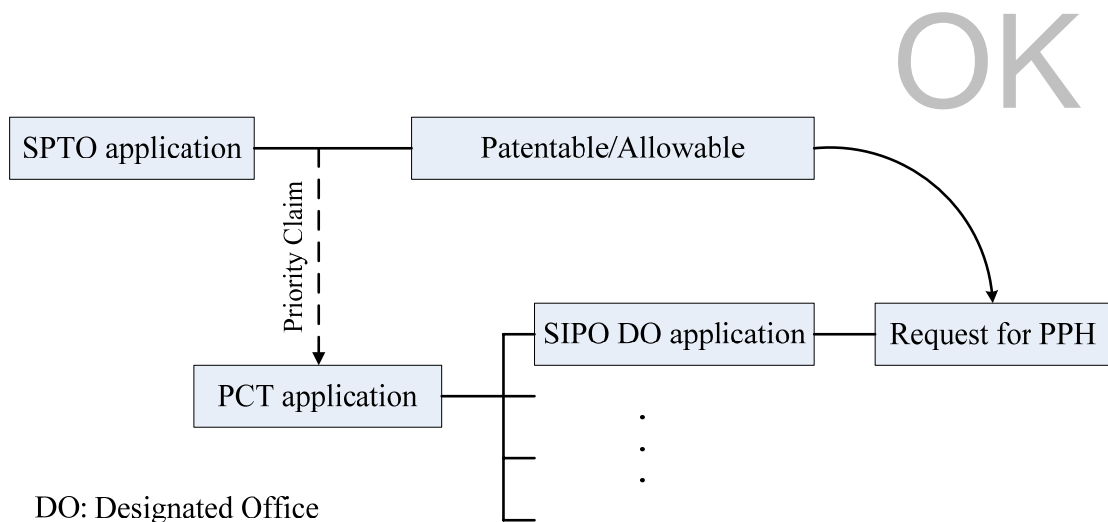

C

A case meeting requirement (a) (i)  
- Paris route, Domestic priority -

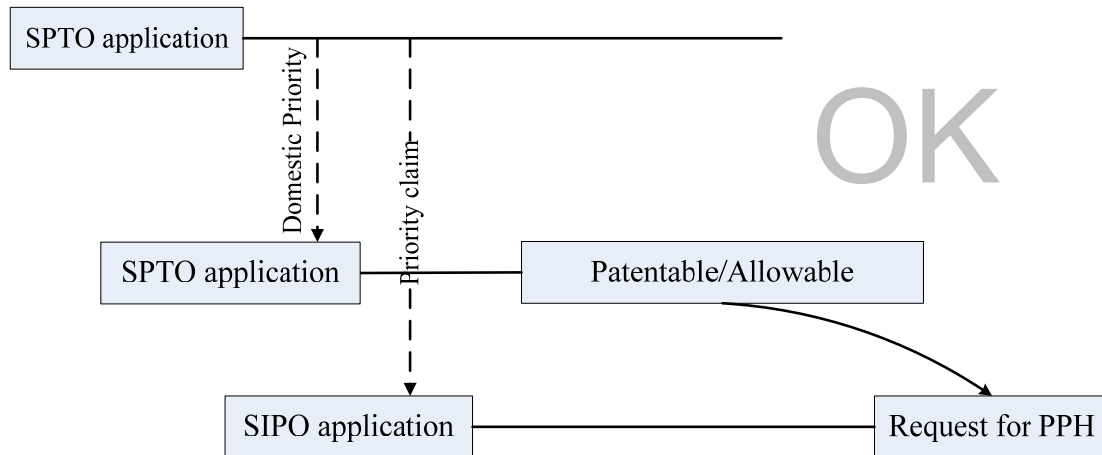

D

A case not meeting requirement (a)  
- Paris route, but the first application is from the third country -

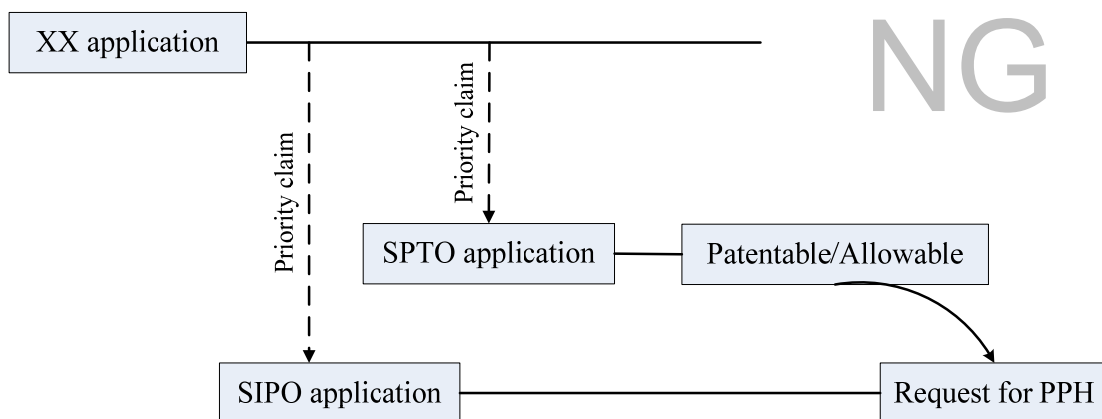

XX: the office other than the SPTO

**E**

A case not meeting requirement (a)  
- PCT route, but the first application is from the third country -

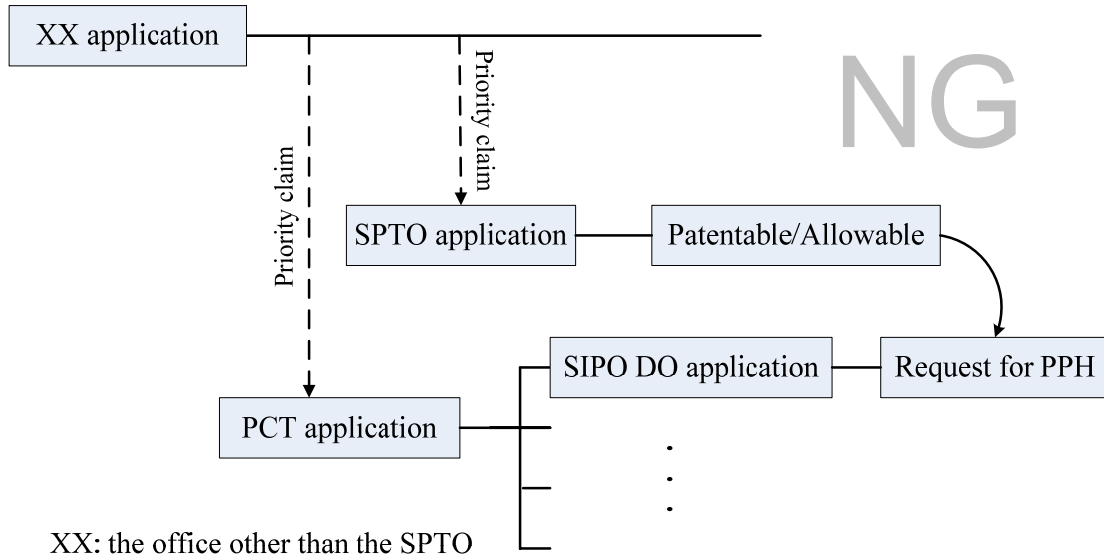

**F**

A case meeting requirement (a) (i)  
- Paris route & complex priority -

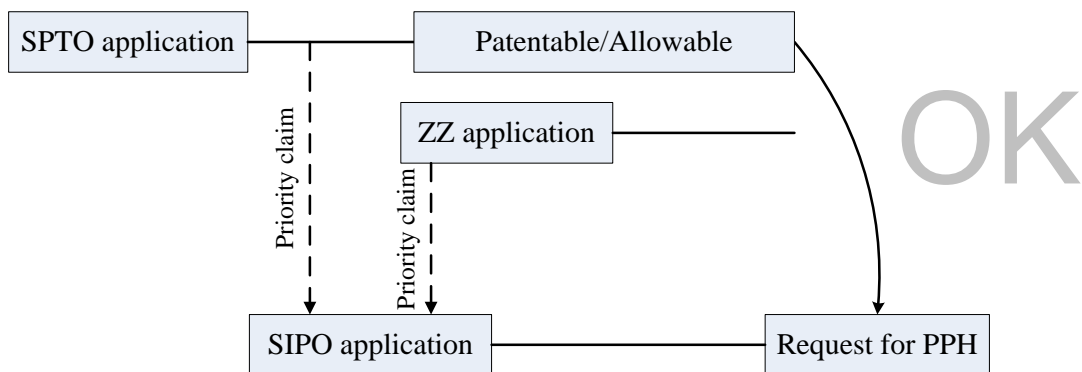

ZZ: any office

(The first application is from the SPTO)



G

A case meeting requirement (a) (i)  
- Paris route & divisional application -

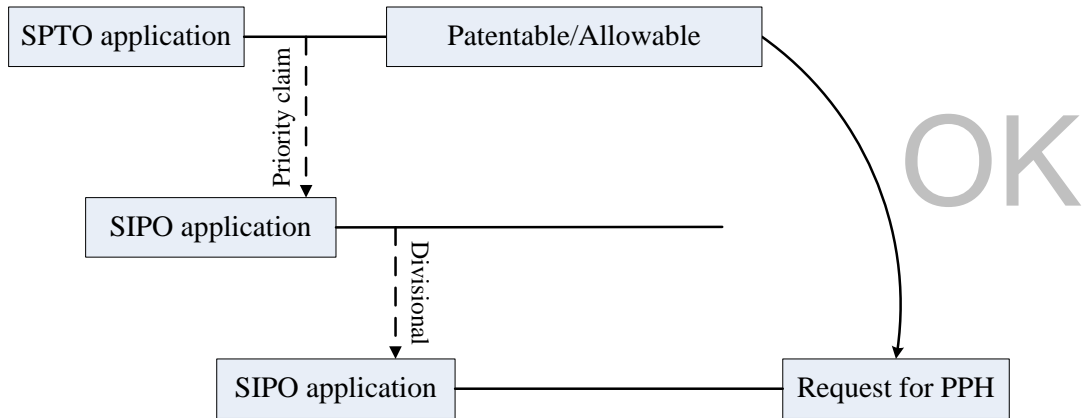

H

A case meeting requirement (a) (i)  
- PCT route -

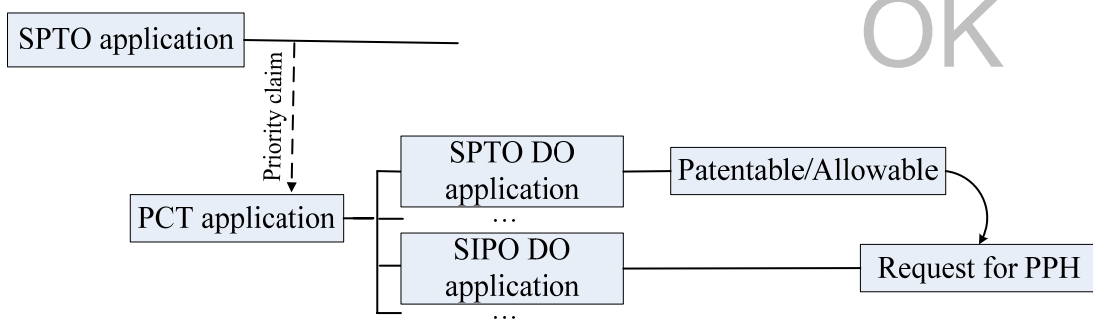

I

A case meeting requirement (a) (ii)  
- Direct PCT route -

OK

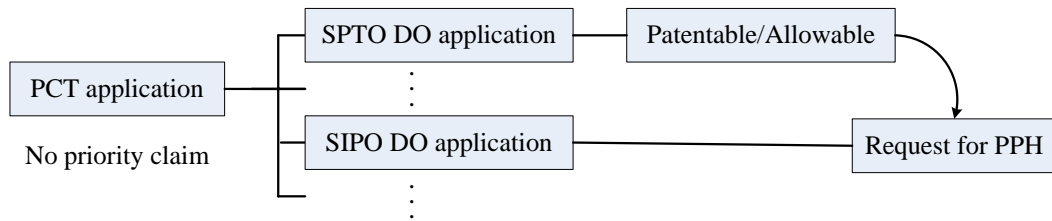

J

A case meeting requirement (a) (iii)  
- Direct PCT & Paris route -

OK

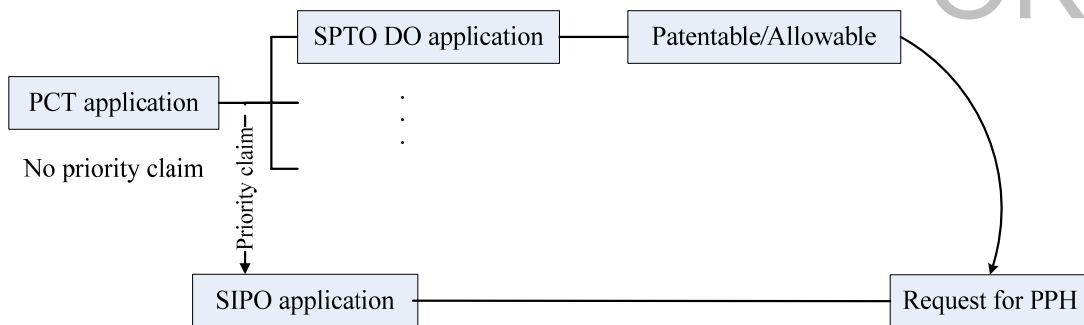

**K**

A case meeting requirement (a) (ii)  
- Direct PCT & PCT route -

OK

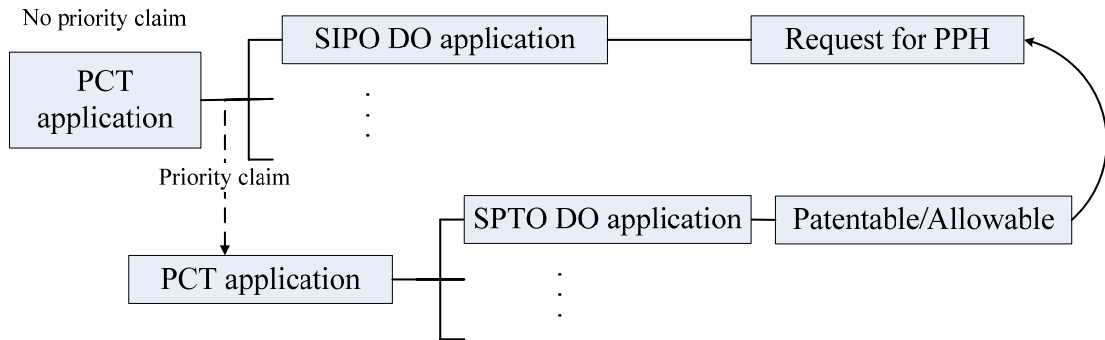

**L**

A case meeting requirement (a) (iii)  
- Direct PCT & PCT route -

OK

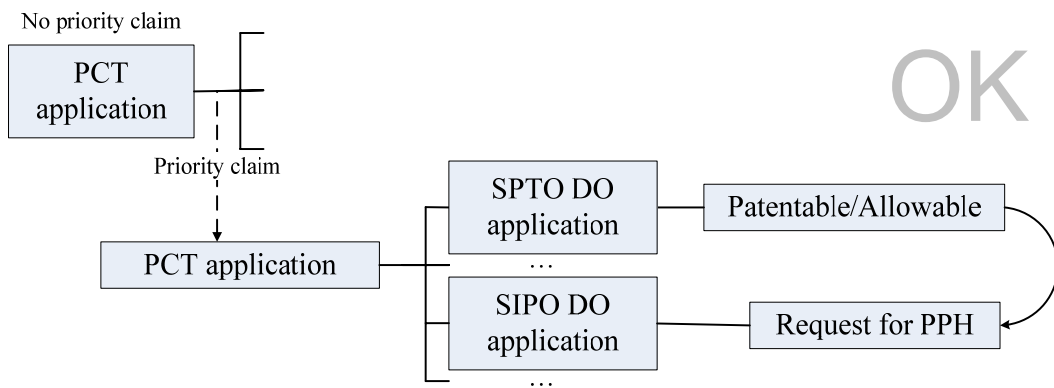

M

A case not meeting requirement (f)  
- Examination has begun before a request for PPH -

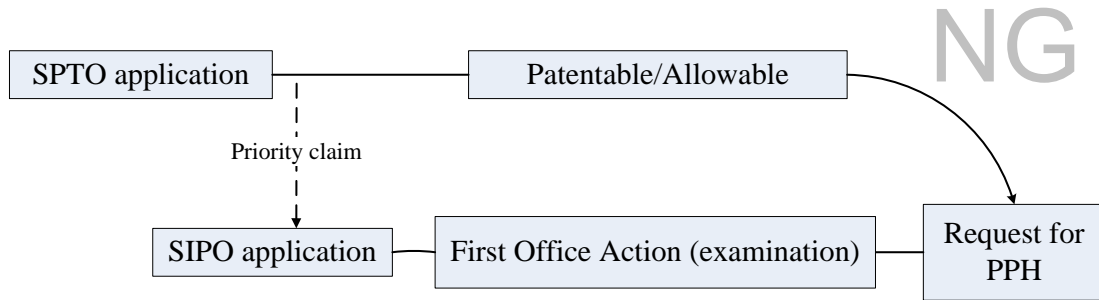

N

A case not meeting requirement (d)  
- The application has not been published at the time of request for PPH -

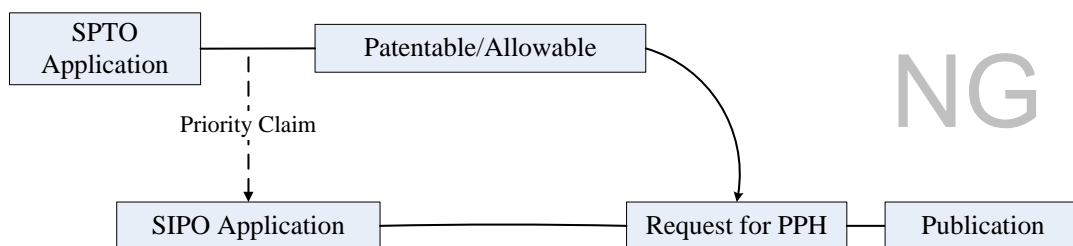

O

A case not meeting requirement (e)  
- The application has not entered into substantive examination stage at the time of request for PPH -

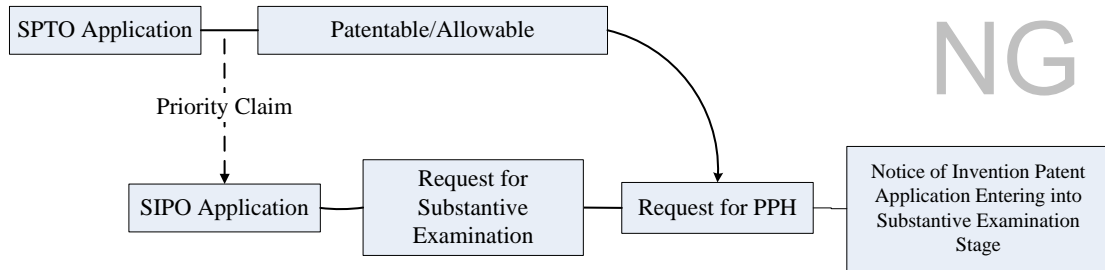

P

A case meeting requirement (e) (exception)  
- PPH request simultaneously with the Request for Substantive Examination -

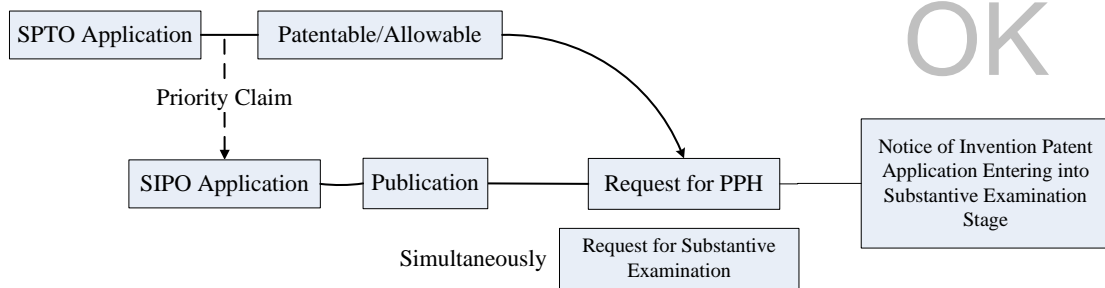

## ANNEX II

**(A) The application is a national phase application of the corresponding international application.**

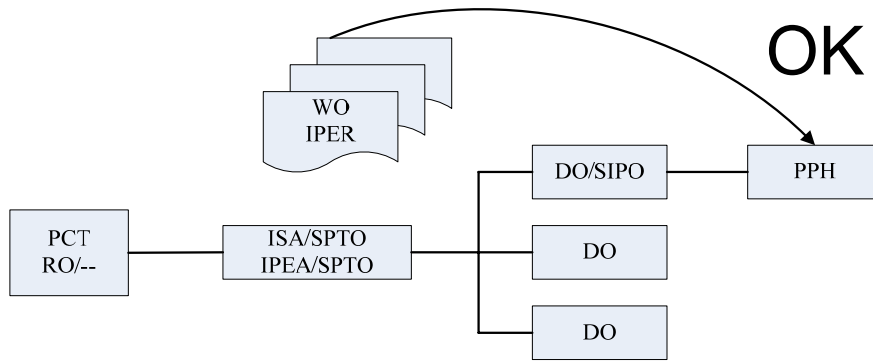

**(A') The application is a national phase application of the corresponding international application.  
(The corresponding international application claims priority from a national application.)**

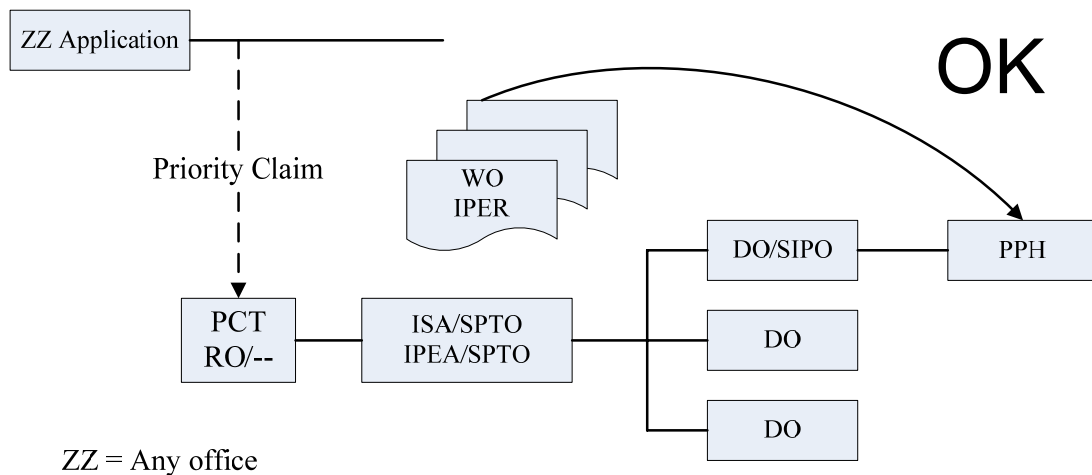

**(A'') The application is a national phase application of the corresponding international application.  
 (The corresponding international application claims priority from an international application.)**

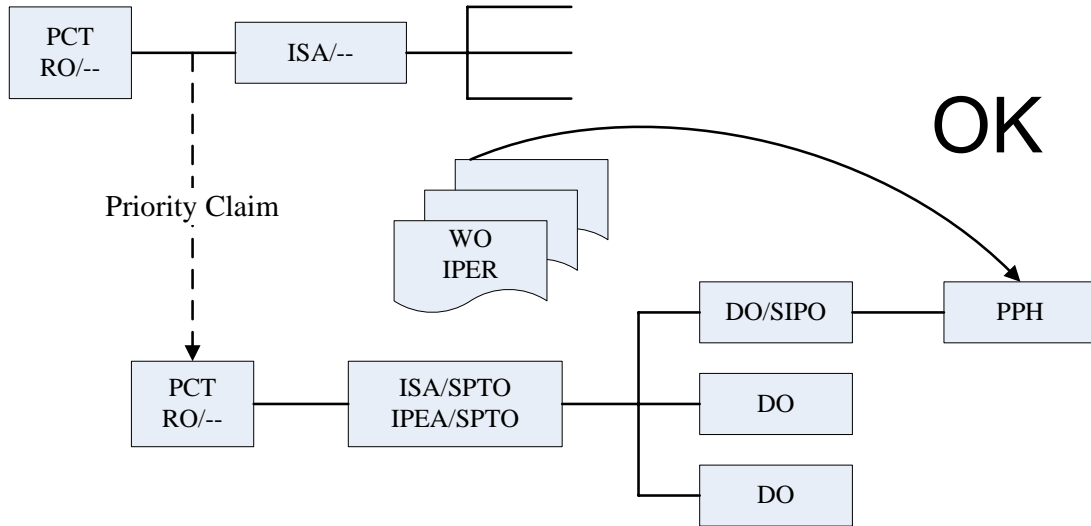

**(B) The application is a national application as a basis of the priority claim of the corresponding international application.**

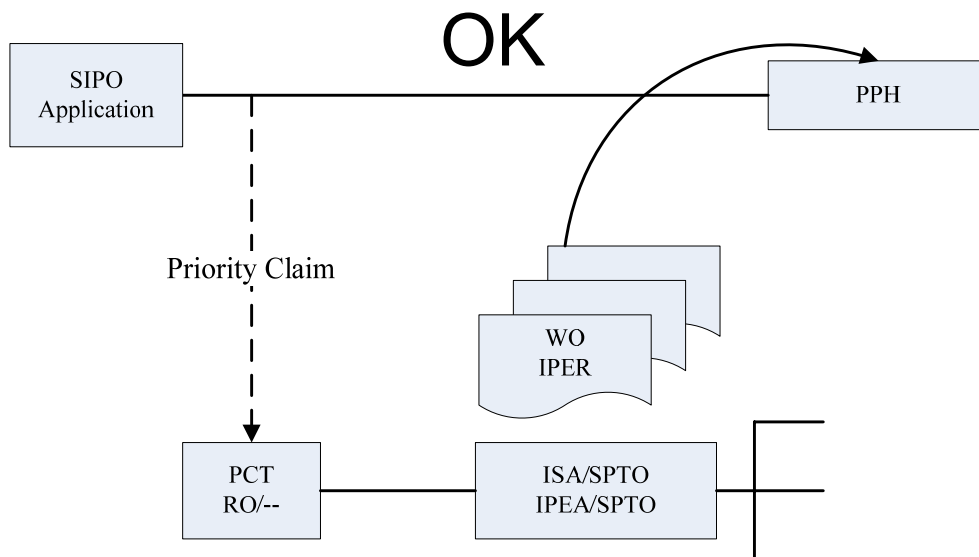

**(C) The application is a national phase application of an international application claiming priority from the corresponding international application.**

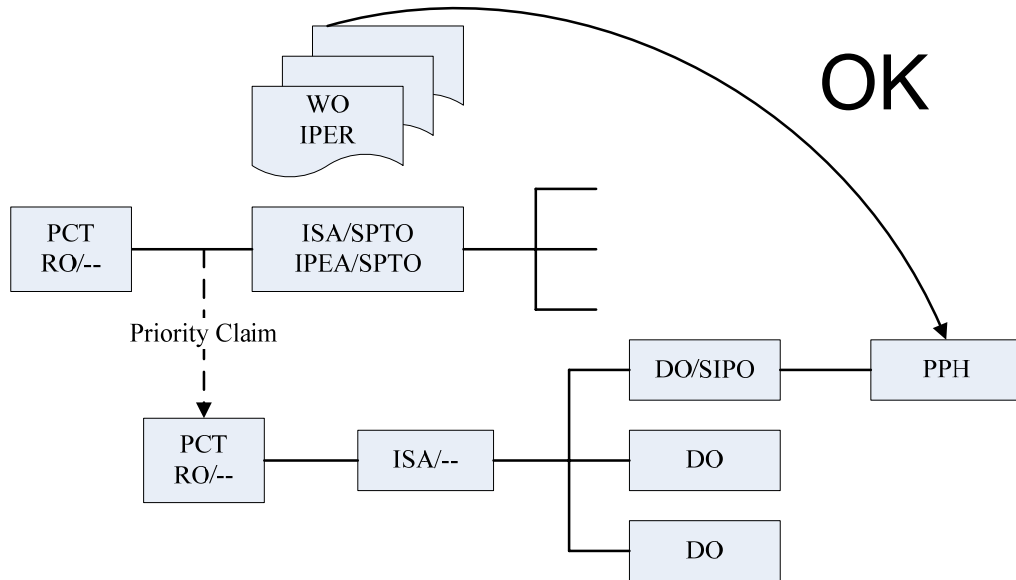

**(D) The application is a national application claiming foreign/domestic priority from the corresponding international application.**

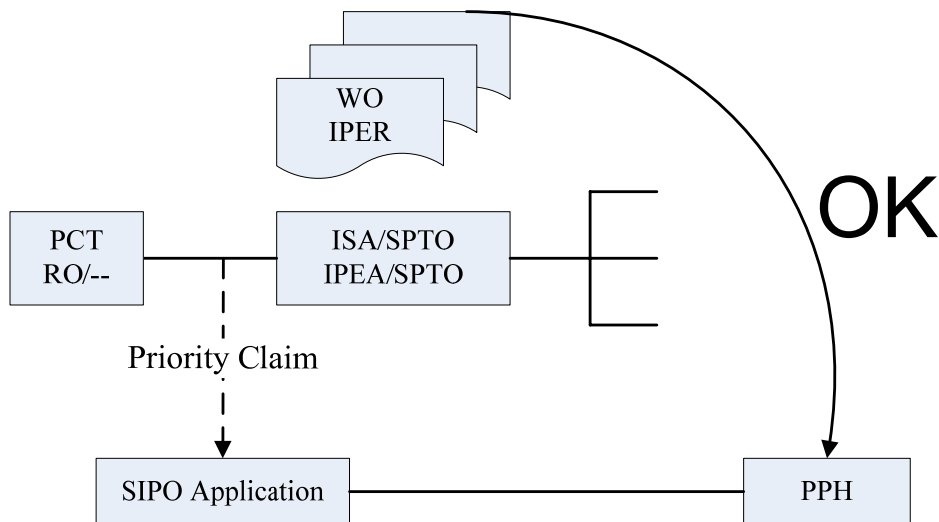



**(E1) The application is a divisional application of an application which satisfies the requirement (A).**

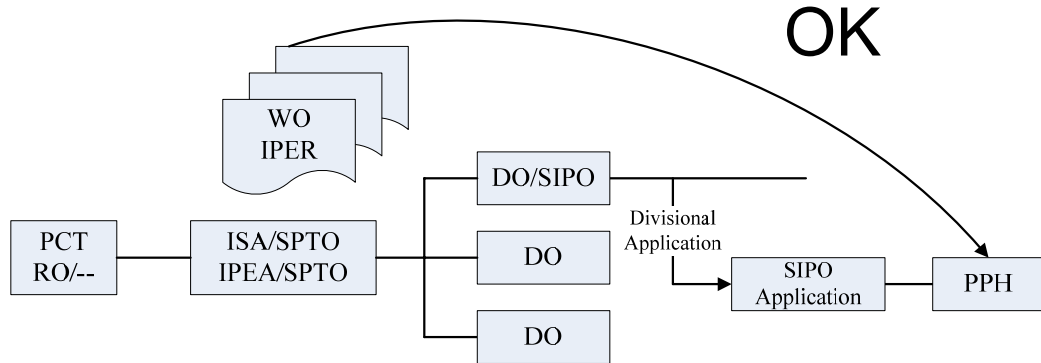

**(E2) The application is an application claiming domestic priority from an application which satisfies the requirement (B).**

