

Procedures to File a Request to the State Intellectual Property Office of the P.R.China (SIPO) under the Patent Prosecution Highway (PPH) Pilot Program between the SIPO and the National Institute of Industrial Property of Brazil (INPI)

The PPH SIPO-INPI Pilot Project will commence on February 1st, 2018 for an initial period of two years, or until each of the Offices has accepted 200 applications under the PPH SIPO-INPI Pilot Project, whichever occurs first. The pilot period may be extended if necessary until the SIPO and INPI receive sufficient number of PPH requests to adequately assess the feasibility of PPH program.

The Offices may also terminate the PPH pilot program if the volume of participation exceeds manageable level, or for any other reason. Ex Ante notice will be published if the PPH pilot program is terminated.

PPH using the national work products from the INPI

Applicants can request accelerated examination by a prescribed procedure including submission of relevant documents on an application which is filed with the SIPO and satisfies the following requirements under the SIPO-INPI Patent Prosecution Highway (PPH) pilot program based on the INPI application.

When filing a request for the PPH pilot program, an applicant must submit a request form "Request for Participation in the Patent Prosecution Highway Pilot Program" to the SIPO.

1. Requirements

- (a) Both the SIPO patent application on which PPH is requested and the INPI patent or utility model application being the basis of the PPH request shall be corresponding applications having the same earliest date (either a priority date or a filing date). The oldest application of the patent family must be applied at the SIPO or the INPI, or at the offices as Receiving Office for PCT-route. The applications of Paris-Route and Direct-PCT-Route will be eligible.***

The expression "corresponding applications" should not be necessarily construed as referred to the application on which a priority claim is based, but it could refer to the application derived from the application on which priority is claimed. For example, a divisional application of the application or an application claiming national priority of the application on which priority is claimed. In this regard, however, divisional patent applications will not be accepted, unless (i) they are directly divided from the original

application, as well as (ii) the division of the application has also been required in the Office of Earlier Examination (OEE).

For example, the SIPO application may be:

- (i) an application which validly claims priority under the Paris Convention to the INPI application(s) (examples are provided in ANNEX I, Figure A, B,C, F, G and H), or
- (ii) an application which provides the basis of a valid priority claim under the Paris Convention for the INPI application(s) (including PCT national phase application(s)) (examples are provided in Annex I, Figures Q and R), or
- (iii) an application which shares a common priority document filed to the SIPO/INPI with the INPI application(s)(including PCT national phase application(s)) (examples is provided in Annex I, Figure D,E,J,K and L), or
- (iv) a PCT national phase application where both the SIPO application and the INPI application(s) are derived from a common PCT international application having no priority claim (an example is provided in ANNEX I, Figure I).

The number of requirements for participation in SIPO will be limited at 200, within which the number of applications which meet the requirement (a) (ii) will be limited at 20, independently whether applications were accepted at the PPH SIPO-INPI Pilot Project by the SIPO.

- (b) ***The corresponding application has been substantively examined by INPI and has one or more claims considered as allowable by the INPI.***

Claims considered allowable shall be expressly identified as such in the INPI's "Decision to Grant" and they will be the basis for the request for participation in the PPH project.

- (c) ***All claims in the SIPO application (for which an accelerated examination under the PPH pilot program is requested), as originally filed or as amended, must sufficiently correspond to one or more of those claims considered as allowable by the INPI.***

Claims are considered to "sufficiently correspond" where, accounting for differences due to translations and claim format, the claims in the SIPO are of the same or similar scope as the claims in the INPI, or the claims in the SIPO are narrower in scope than the claims in the INPI.

In this regard, a claim that is narrower in scope occurs when a INPI claim is amended to be further limited by an additional technical feature that is supported in the specification (description and/or claims).

A claim in the SIPO which introduces a new/different category of claims to those claims determined to be patentable/allowable in the INPI is not considered to sufficiently correspond. For example, the INPI claims only contain claims to a process of

manufacturing a product, then the claims in the SIPO are not considered to sufficiently correspond if the SIPO claims introduce product claims that are dependent on the corresponding process claims.

It is not necessary to include “all” claims determined to be patentable/allowable in the INPI in an application in the SIPO (the deletion of claims is allowable). For example, in the case where an application in the INPI contains 5 claims determined to be patentable/allowable, the application in the SIPO may contain only 3 of these 5 claims.

Any claims amended or added after the grant of the request for participation in the PPH pilot program need to sufficiently correspond to the claims indicated as patentable/allowable in the INPI application when applicants have not received any office action related to substantive examination. Any claims amended or added after the grant of the request for participation in the PPH pilot program need not to sufficiently correspond to the claims indicated as patentable/allowable in the INPI application when applicants need to amend claims in order to overcome the reasons for refusal raised by examiners. Any amendment outside of the claim correspondence requirement is subject to examiners’ discretion.

Note that any applicant to the SIPO may amend the application including its claims on its or his own initiative when a request for substantive examination is made, and within the time limit of three months after the receipt of the *Notice of Invention Patent Application Entering into Substantive Examination Stage*. Therefore, an applicant needs to care about the time limit of amendment in order to make claims in the SIPO application correspond to the claims determined to be patentable/allowable in the INPI.

(d) *The SIPO application must have been published.*

The applicant must have received the *Notice of Publication of Invention Patent Application* issued from the SIPO before, or when, filing the PPH request.

(e) *The SIPO application must have entered into substantive examination stage.*

The applicant must have received the *Notice of Invention Patent Application Entering into Substantive Examination Stage* issued from the SIPO before, or when, filing the PPH request.

Note that as an exception, the applicant may file a PPH request simultaneously with the Request for Substantive Examination.

(f) *The SIPO has not begun examination of the application at the time of request for the PPH.*

The applicant should have not received any office action issued from the substantive examination departments in the SIPO before, or when, filing the PPH request.

(g) *The SIPO application must be electronic patent application.*

The applicant must convert the paper based SIPO application into electronic application before filing the PPH request.

2. Documents to be submitted

Documents (a) to (c) below must be submitted by attaching to “*Request for Participation in the Patent Prosecution Highway (PPH) Pilot Program*”.

Note that even when it is not needed to submit certain documents below, the name of the documents must be listed in the “*Request for Participation in the Patent Prosecution Highway (PPH) Pilot Program*” (Please refer to the example form below for the details).

(a) *Copies of all office actions (which are relevant to substantive examination for patentability in the INPI) which were issued for the corresponding application in the name of the INPI, and translations of them.*

Either Chinese or English is acceptable as translation language. If it is impossible for the examiner to understand the translated office action, the examiner can request the applicant to resubmit translations.

(b) *Copies of all claims determined as allowable by the INPI in a substantive examination carried out in the name of the INPI, and translations of them.*

Either Chinese or English is acceptable as translation language. If it is impossible for the examiner to understand the translated claims, the examiner can request the applicant to resubmit translations.

(c) *Copies of cited references*

The documents to be submitted are those cited in the above-mentioned office actions. Documents which are only referred to as references and consequently do not constitute reason for refusal do not have to be submitted.

If the references are patent documents, the applicant does not have to submit them¹. When the SIPO does not possess the patent document, the applicant has to submit the patent document at the examiner’s request. Non-patent literature must always be submitted. The translations of the references are unnecessary.

¹Note that even when it is not needed to submit copies of references, the name of the references must be listed in the “*Request for Participation in the Patent Prosecution Highway (PPH) Pilot Program*”.

When the applicant has already submitted above documents (a) to (c) to the SIPO through simultaneous or past procedures, the applicant may incorporate the documents by reference and does not have to attach them.

3. Example of “Request for Participation in the Patent Prosecution Highway (PPH) Pilot Program” for filing request of an accelerated examination under the PPH pilot program

(a) Circumstances

When an applicant files a request for an accelerated examination under the PPH pilot program to the SIPO, the applicant must submit a request form “*Request for Participation in the Patent Prosecution Highway (PPH) Pilot Program*”.

The applicant must indicate that the application is included in (i) to (iii) of 1.(a), and that the accelerated examination is requested under the PPH pilot program. The application number, publication number, or a patent number of the corresponding INPI application(s) also must be written.

In the case that the application which has one or more claims that are determined to be patentable/allowable is different from the INPI application(s) included in (i) to (iii) of 1.(a) (for example, the divisional application of the basic application), the application number, publication number, or a patent number of the application(s) which has claims determined to be patentable/allowable and the relationship between those applications also must be explained.

(b) Documents to be submitted

The applicant must list all required documents mentioned above 2. in an identifiable way, even when the applicant is exempted to submit certain documents.

(c) Claim correspondence

The applicant requesting PPH must indicate in section D of the “*Request for Participation in the Patent Prosecution Highway (PPH) Pilot Program*” how all claims in the SIPO application sufficiently correspond to the patentable/allowable claims in the INPI application.

When claims are just literal translations of each other, the applicant can just enter “they are the same” in the table. When claims are not just literal translations, it is necessary to explain the sufficient correspondence of each claim based on the criteria 1.(c) (Please refer to the sample form below).

(d) Notice

An applicant can file the “*Request for Participation in the Patent Prosecution Highway (PPH) Pilot Program*” to the SIPO through on-line procedures only.

4. Procedure for the accelerated examination under the PPH pilot program

The SIPO decides whether the application can be entitled to the status for an accelerated examination under the PPH when it receives a request with the documents stated above. When the SIPO decides that the request is acceptable, the application is assigned a special status for an accelerated examination under the PPH.

In those instances where the request does not meet all the requirements set forth above, the applicant will be notified and the defects in the request will be identified. The applicant may be given opportunity, one time only, to correct certain specified defects. If the request is not approved, the applicant may resubmit the request up to one time. If the resubmitted request is still not approved, the applicant will be notified and the application will await action in its regular turn.

Sample Form

参与专利审查高速路（PPH）试点项目请求表

PPH

Request for participation in the Patent Prosecution Highway (PPH) Pilot Program (Sample Form)

A. 著录数据	
申请号	
B. 请求	
申请人请求参与专利审查高速路（PPH）试点项目基于：	
在先审查局 (OEE)	
OEE 工作结果类型	<input type="checkbox"/> 国家/地区的审查意见
	<input type="checkbox"/> WO-ISA, WO-IPEA 或 IPER
OEE 申请号	
本申请与 OEE 申请的关系	
C. 文件提交	
第 I 栏 OEE 工作结果及其所需译文	
1.	<input type="checkbox"/> 提交了 OEE 工作结果的副本 <input type="checkbox"/> 请求通过案卷访问系统或 PATENTSCOPE 获取上述文件
2.	<input type="checkbox"/> 提交了 1 之所述文件的译文 <input type="checkbox"/> 请求通过案卷访问系统或 PATENTSCOPE 获取上述文件
第 II 栏 OEE 认定为可授权的所有权利要求的副本及其所需译文	
3.	<input type="checkbox"/> 提交了 OEE 认定为可授权的所有权利要求的副本 <input type="checkbox"/> 请求通过案卷访问系统或 PATENTSCOPE 获取上述文件
4.	<input type="checkbox"/> 提交了 3 之所述文件的译文 <input type="checkbox"/> 请求通过案卷访问系统或 PATENTSCOPE 获取上述文件
第 III 栏 OEE 工作结果引用的文件	
5.	<input type="checkbox"/> 提交了 OEE 工作结果引用的所有文件的副本（专利文献除外） <input type="checkbox"/> 无引用文件
第 IV 栏已提交文件	
6.	<input type="checkbox"/> 若上述某些文件已经提交，请予说明： 申请人于__年__月__日在 CN_____中提交了_____文件
D. 权利要求对应性	

ANNEX I

A

A case meeting requirement (a) (i)
- Paris route -

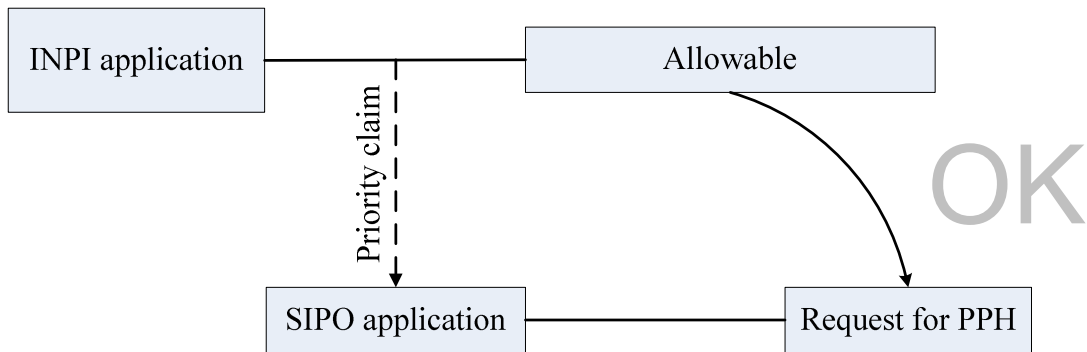

B

A case meeting requirement (a) (i)
- PCT route -

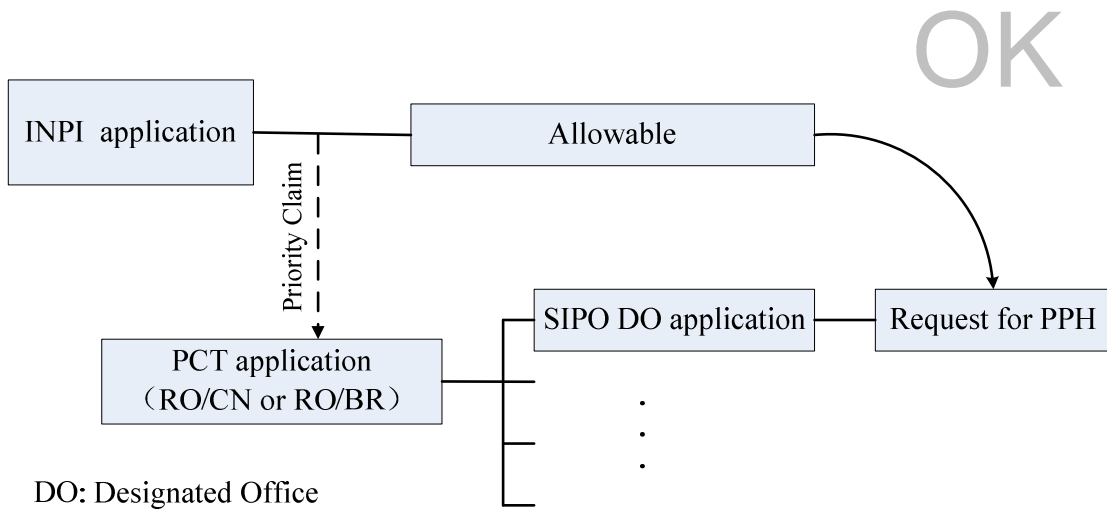

C

A case meeting requirement (a) (i)
- Paris route, Domestic priority -

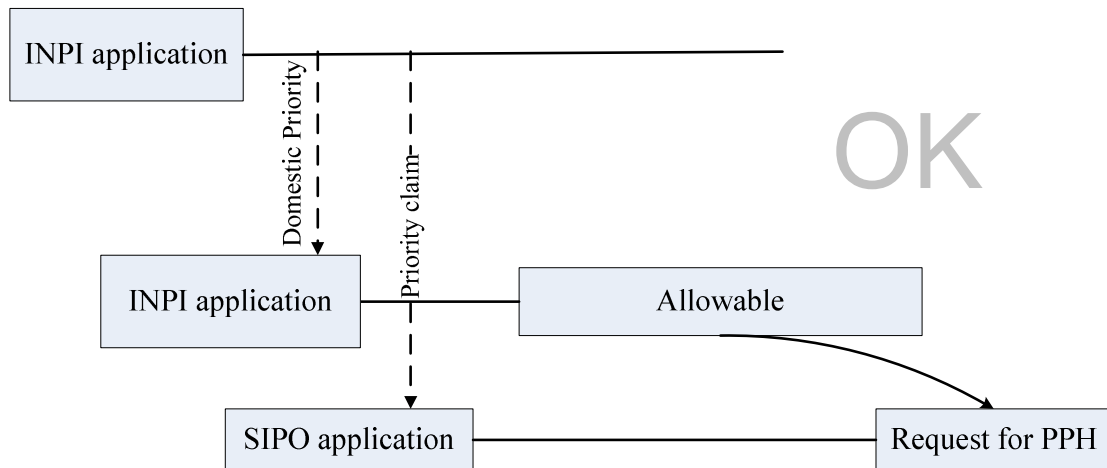

D

A case not meeting requirement (a) (iii)
- Paris route, but the first application is from the third country -

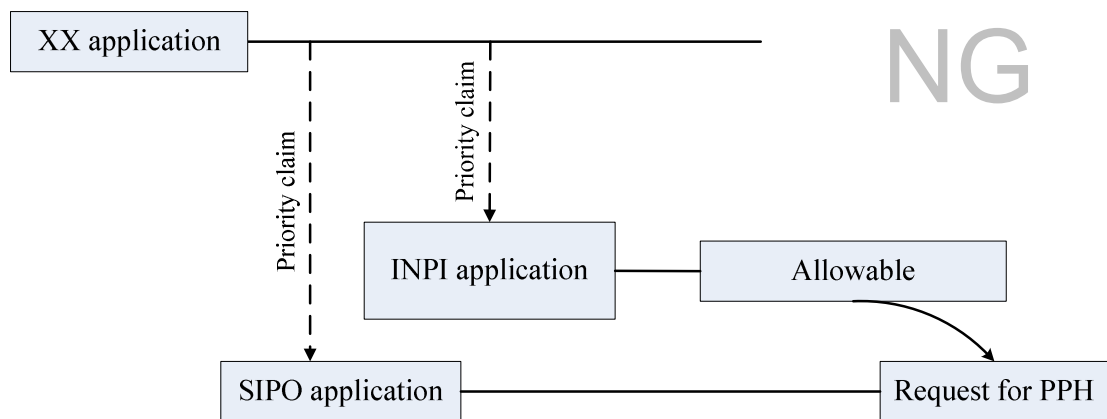

XX: the office other than the INPI or the SIPO

E

A case not meeting requirement (a) (iii)
- PCT route, but the first application is from the third country -

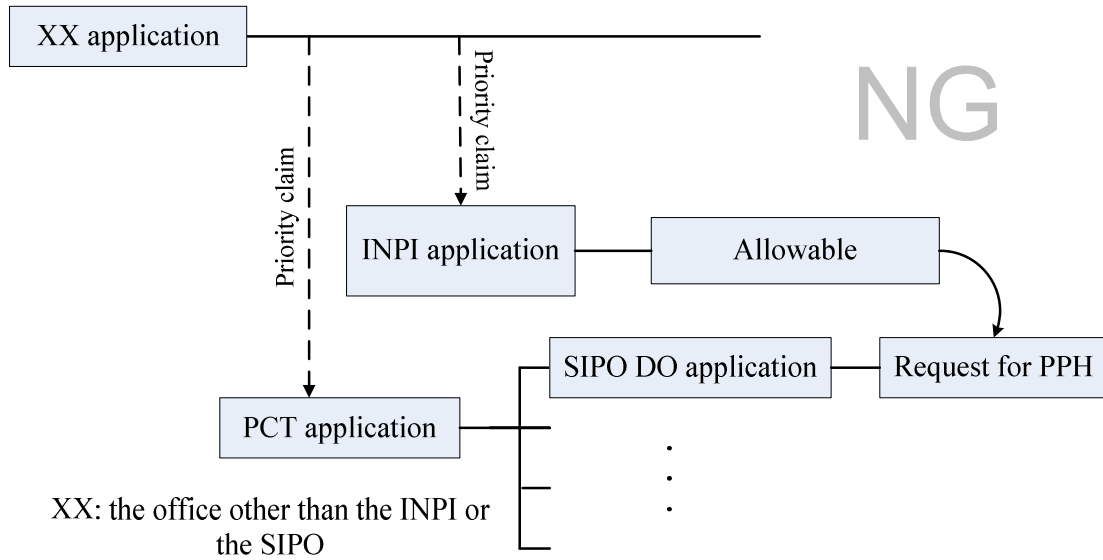

F

A case meeting requirement (a) (i)
- Paris route & complex priority -

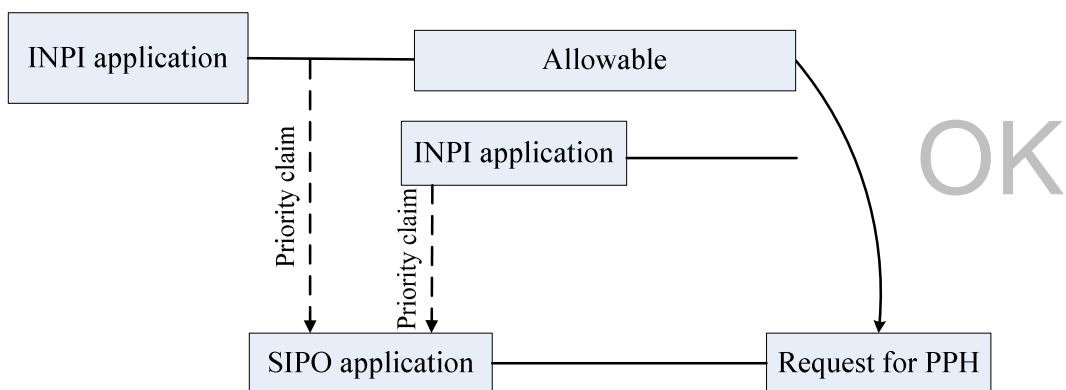

G

A case meeting requirement (a) (i)
- Paris route & divisional application -

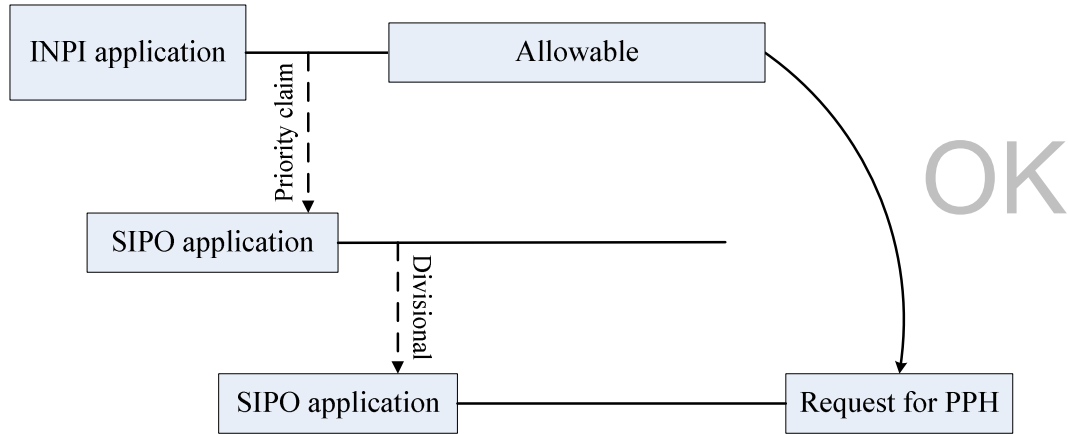

H

A case meeting requirement (a) (i)
- PCT route -

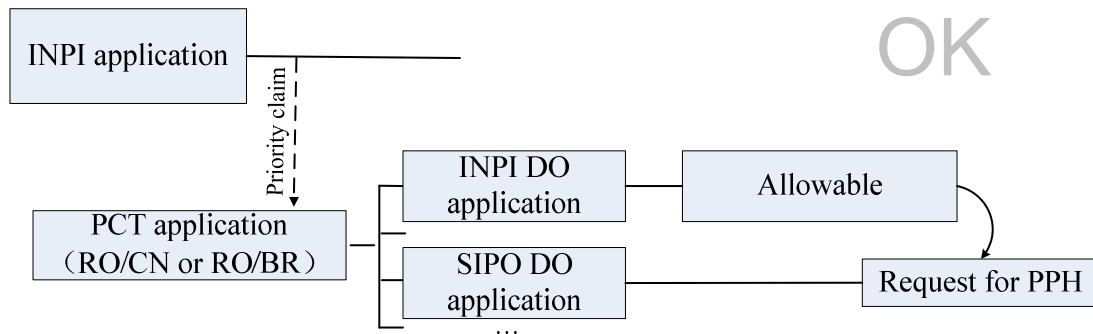

I

A case meeting requirement (a) (iv)

- Direct PCT route -

OK

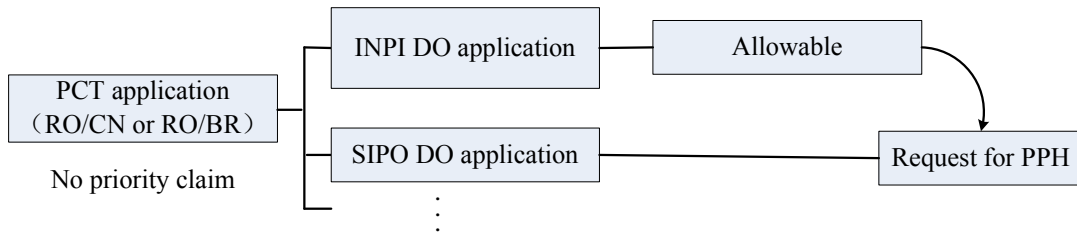

J

A case meeting requirement (a) (iii)

- Direct PCT & Paris route -

OK

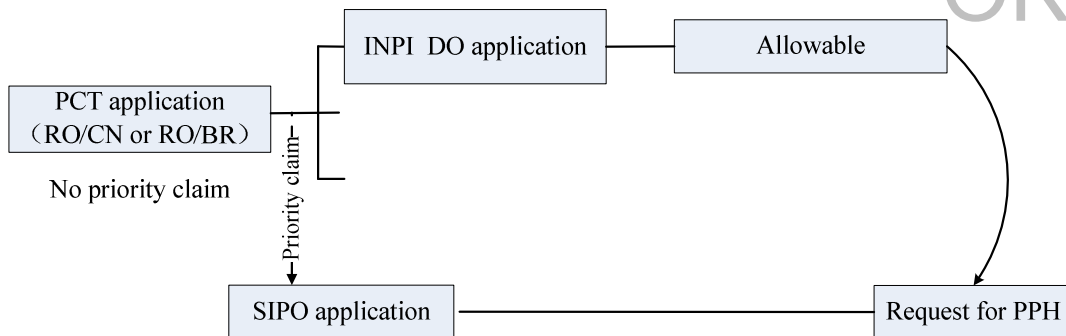

K

A case meeting requirement (a) (iii)
- Direct PCT & PCT route -

OK

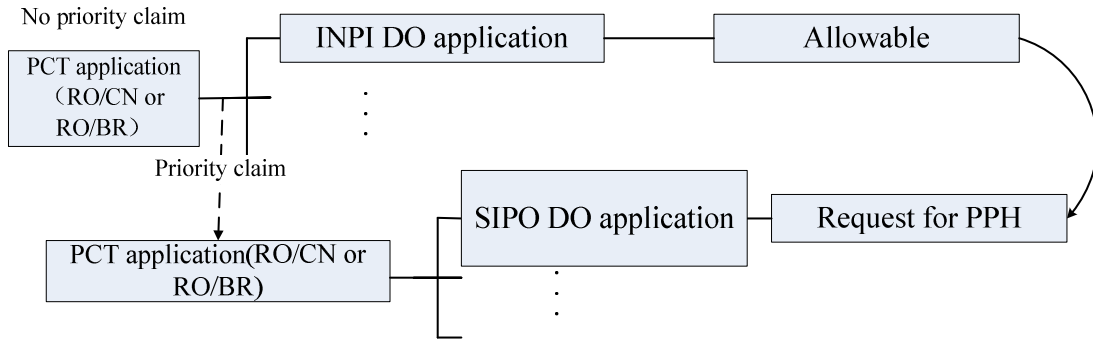

L

A case meeting requirement (a) (iii)
- Direct PCT & PCT route -

OK

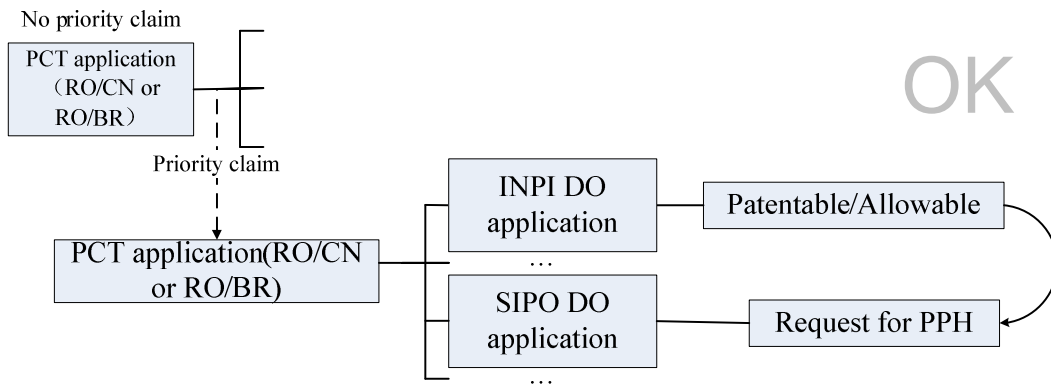

M

A case not meeting requirement (f)
- Examination has begun before a request for PPH -

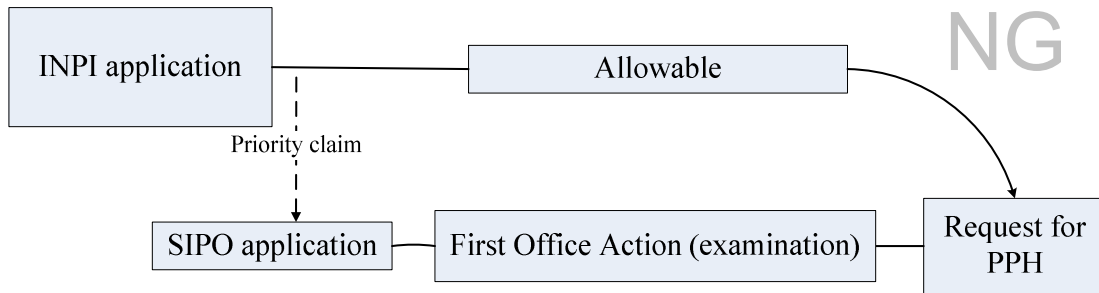

N

A case not meeting requirement (d)
- The application has not been published at the time of request for PPH -

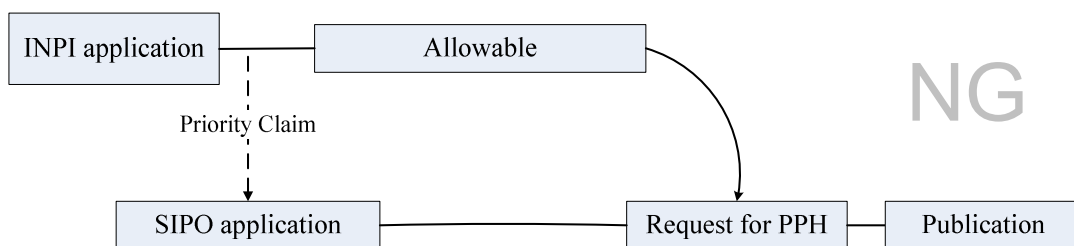

O

A case not meeting requirement (e)
- The application has not entered into substantive examination stage at the time of request for PPH -

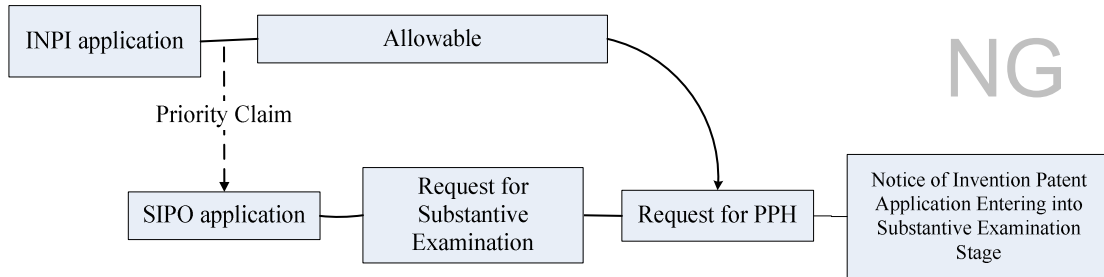

P

A case meeting requirement (e) (exception)
- PPH request simultaneously with the Request for Substantive Examination -

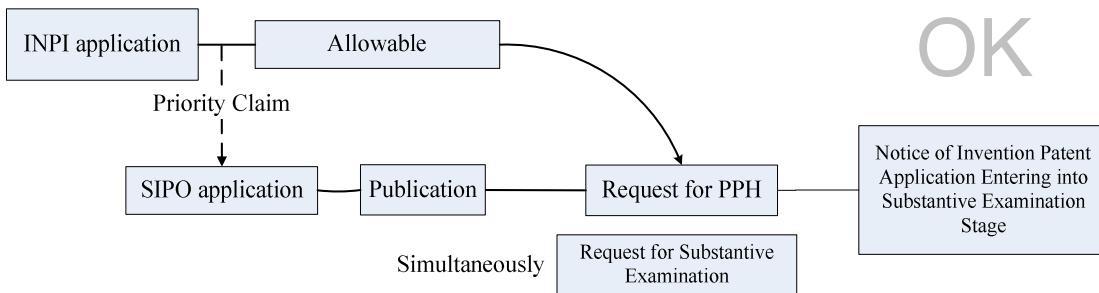

Q

A case meeting requirement (a) (ii)
- Paris route -

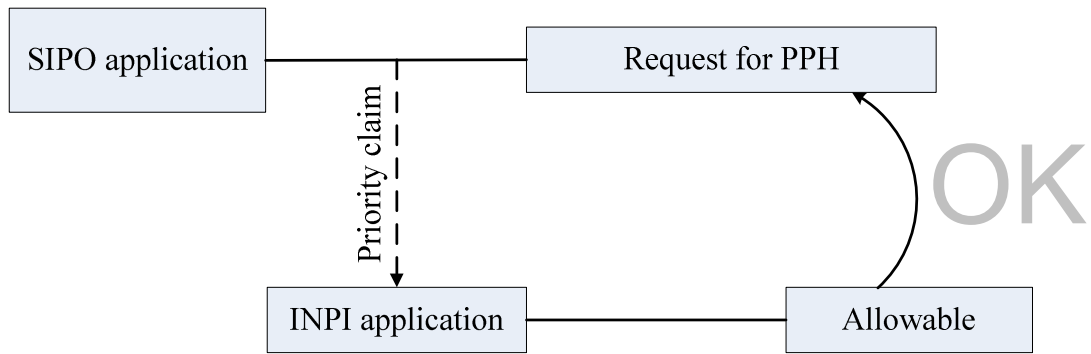

R

A case meeting requirement (a) (ii)
- PCT route -

